

*air, electric & hydraulic  
hammer accessories*



*Pioneer quality makes the difference*

**PIONEER**

**Tool & Forge, Inc.**

October 2008



# Contents

## Terms and Conditions

Approved safety gear such as hard hats, safety glasses, safety shoes and hearing protection should be worn at all times.

Tools should only be used for the work for which they were designed. Never strike and air tool with a hand held hammer. Air tools are designed and heat treated for use only in air tool operations.

Dull tools should never be used. They are hard on the hammer and will break from fatigue.

Tools should not be altered in any way.

Air tools should never be used for prying. This is dangerous and causes breakage.

Hammer parts should always be kept in good repair. Worn bushings and pistons cause excessive shank wear on tools.

When temperatures are below freezing, warm tools prior to use.

Proper reconditioning procedures should be followed to prevent premature breakage.

## Air & Electric Hammer Accessories

## Page

Terms & Conditions	2
Contents	2
Paving Breaker Tools	3 - 4
Rivet Busters	5
Chipping Hammer Tools	6-8
Weld Flux Scaling Chisels	9
Electric Hammer Tools	10
Drill Steel	11
Integral Drill Steel	12
Boom Mounted Demolitions Tools	13-14
Safety Hints & Warnings	15



## Warranty Information

Pioneer tools are guaranteed against defects in material and workmanship. Adjustments will be made on any tool which does not perform to your satisfaction, provided it has not been abused during use. No other warranty is expressed or implied in this catalog.

### NOTE

Other lengths and point styles are available. Please contact us for current pricing. Free freight is provided for orders of \$1,500.00 net to continental US only.

**Telephone:** (724) 337-4700  
**Toll Free:** (800) 359-6408  
**Fax Number:** (724) 337-4707

**Email:** [pioneer@breakersteel.com](mailto:pioneer@breakersteel.com)  
**Website:** [www.breakersteel.com](http://www.breakersteel.com)

# Paving Breaker Tools





Shank Size	Length under collar	Box Qty	Weight	Part Number
 <b>Standard Moil Point</b>				
7/8 x 3-1/4	14"	12	3.75	<b>17114</b>
	18"	12	4.00	<b>17118</b>
1 x 4-1/4	14"	10	4.50	<b>18114</b>
	18"	10	5.25	<b>18118</b>
1-1/8 x 6	24"		6.75	<b>18124</b>
	14"	8	6.00	<b>19114</b>
	18"	8	7.50	<b>19118</b>
1-1/4 x 6	24"		9.00	<b>19124</b>
	36"		12.75	<b>19136</b>
	14"	8	7.50	<b>10114</b>
	18"	8	9.00	<b>10118</b>
	24"		12.00	<b>10124</b>
	36"		16.50	<b>10136</b>

Longer Lengths Available

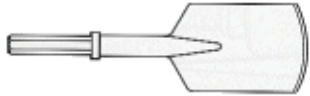
Shank Size	Length under collar	Box Qty	Weight	Part Number
 <b>Heavy Duty Point</b>				
7/8 x 3-1/4	14"	12	4.75	<b>17114HD</b>
	18"	12	5.50	<b>17118HD</b>
1 x 4-1/4	14"	10	5.00	<b>18114HD</b>
	18"	10	6.00	<b>18118HD</b>
1-1/8 x 6	14"	8	6.50	<b>19114HD</b>
	18"	8	8.00	<b>19118HD</b>
1-1/4 x 6	14"	8	8.00	<b>10114HD</b>
	18"	8	9.75	<b>10118HD</b>

Shank Size	Length under collar	Box Qty	Weight	Part Number
 <b>Clay Spade</b>				
7/8 x 3-1/4		6	6.00	<b>1755</b>
1 x 4-1/4		6	7.00	<b>1855</b>
1-1/8 x 6		6	9.00	<b>1955</b>
1-1/4 x 6		6	9.50	<b>1055</b>

Shank Size	Length under collar	Box Qty	Weight	Part Number
 <b>Mastercut Chisel</b>				
1 x 4-1/4	16"	6	6.50	<b>1890</b>
1-1/8 x 6	16"	6	7.75	<b>1990</b>
1-1/4 x 6	16"	6	9.00	<b>1090</b>

Shank Size	Length under collar	Box Qty	Weight	Part Number
 <b>Standard Chisel</b>				
7/8 x 3-1/4	14"	12	3.75	<b>17214</b>
	18"	12	4.00	<b>17218</b>
1 x 4-1/4	14"	10	4.50	<b>18214</b>
	18"	10	5.25	<b>18218</b>
1-1/8 x 6	24"		6.75	<b>18224</b>
	14"	8	6.00	<b>19214</b>
	18"	8	7.50	<b>19218</b>
1-1/4 x 6	24"		9.00	<b>19224</b>
	36"		12.75	<b>19236</b>
	14"	8	7.50	<b>10214</b>
	18"	8	9.00	<b>10218</b>
	24"		12.00	<b>10224</b>
	36"		16.50	<b>10236</b>

Longer Lengths Available

Shank Size	Length under collar	Box Qty	Weight	Part Number
 <b>Heavy Duty Chisel</b>				
7/8 x 3-1/4	14"	12	4.75	<b>17214HD</b>
	18"	12	5.50	<b>17218HD</b>
1 x 4-1/4	14"	10	5.00	<b>18214HD</b>
	18"	10	6.00	<b>18218HD</b>
1-1/8 x 6	14"	8	6.50	<b>19214HD</b>
	18"	8	8.00	<b>19218HD</b>
1-1/4 x 6	14"	8	8.00	<b>10214HD</b>
	18"	8	9.75	<b>10218HD</b>

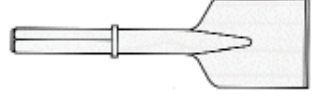
Shank Size	Length under collar	Box Qty	Weight	Part Number
 <b>5" Asphalt Cutter</b>				
7/8 x 3-1/4		6	6.00	<b>1750</b>
1 x 4-1/4		6	7.00	<b>1850</b>
1-1/8 x 6		6	9.00	<b>1950</b>
1-1/4 x 6		6	9.50	<b>1050</b>

Shank Size	Length under collar	Box Qty	Weight	Part Number
 <b>Frost Wedge</b> (Blade 2" x 12")				
1-1/8 x 6	17"	5	12.00	<b>1987</b>
1-1/4 x 6	17"	5	13.00	<b>1087</b>

Telephone: (724) 337-4700  
 Toll Free: (800) 359-6408  
 Fax Number: (724) 337-4707

Email: [pioneer@breakersteel.com](mailto:pioneer@breakersteel.com)  
 Website: [www.breakersteel.com](http://www.breakersteel.com)



# Paving Breaker Tools

**Shank Size   Length  
under  
collar   Box  
Qty   Weight   Part  
Number**



### Standard 3" Chisel

7/8 x 3-1/4	14"	8	4.00	<b>17314</b>
	18"	8	5.00	<b>17318</b>
1 x 4-1/4	14"	8	5.00	<b>18314</b>
	18"	8	5.75	<b>18318</b>
	24"		7.25	<b>18324</b>
1-1/8 x 6	14"	6	6.50	<b>19314</b>
	18"	6	8.00	<b>19318</b>
	24"		9.50	<b>19324</b>
	36"		13.25	<b>19336</b>
1-1/4 x 6	14"	6	8.00	<b>10314</b>
	18"	6	9.75	<b>10318</b>
	24"		12.50	<b>10324</b>
	36"		18.00	<b>10336</b>

**Longer Lengths Available**



### Bushing Tool

7/8 x 3-1/4	9"	8	6.50	<b>1782</b>
1 x 4-1/4	9"	8	6.75	<b>1882</b>
1-1/8 x 6	9"	8	7.00	<b>1982</b>
1-1/4 x 6	9"	8	7.50	<b>1082</b>



### Digging Chisel (Blade Size 3" x 9")

1 x 4-1/4	16"	6	6.75	<b>1894</b>
1-1/8 x 6	18"	6	8.00	<b>1994</b>
1-1/4 x 6	18"	6	8.50	<b>1094</b>

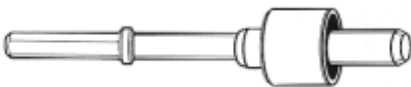

### PipeDrivRs®

1-1/8 x 6	12"	6	7.75	<b>1984</b>
1-1/4 x 6	12"	6	8.00	<b>1084</b>
Cup Only			3.75	<b>184C</b>

**Shank Size   Length  
under  
collar   Box  
Qty   Weight   Part  
Number**

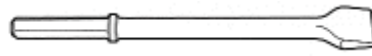

### Heavy Duty 3" Chisel

1 x 4-1/4	16"	6	6.25	<b>18316HD</b>
	24"		9.50	<b>18324HD</b>
1-1/8 x 6	16"	6	8.00	<b>19316HD</b>
	24"		12.00	<b>19324HD</b>
1-1/4 x 6	16"	6	9.50	<b>10316HD</b>
	24"		14.25	<b>10324HD</b>

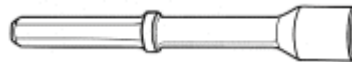

### Rod or Pin Driver

For rod sizes up to 1-1/4 unless specified otherwise

7/8 x 3-1/4	9"	8	7.00	<b>179220</b>
1 x 4-1/4	9"	8	7.00	<b>189220</b>
1-1/8 x 6	9"	8	9.00	<b>199220</b>
1-1/4 x 6	9"	8	11.50	<b>109220</b>

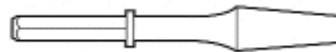

### Rock Breaker

1 x 4-1/4	14-1/2"	5	9.75	<b>1885</b>
1-1/8 x 6	14-1/2"	5	10.75	<b>1985</b>
1-1/4 x 6	14-1/2"	5	11.25	<b>1085</b>



### Tamping Pad

6" Square	14.00	<b>1966</b>
8" Square	22.00	<b>1968</b>
7" Round	16.00	<b>196R</b>

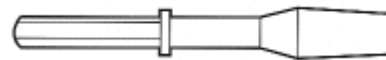

### Detachable Shank

1 x 4-1/4	8	5.25	<b>1896</b>
1-1/8 x 6	8	6.75	<b>1996</b>
1-1/4 x 6	8	7.25	<b>1096</b>

**Telephone:** (724) 337-4700

**Toll Free:** (800) 359-6408

**Fax Number:** (724) 337-4707

**4**

**Email:** [pioneer@breakersteel.com](mailto:pioneer@breakersteel.com)

**Website:** [www.breakersteel.com](http://www.breakersteel.com)

# Rivet Busters



Item	Length	Box Qty	Weight	Part Number	Item	Length	Box Qty	Weight	Part Number
------	--------	---------	--------	-------------	------	--------	---------	--------	-------------

## Standard 80X Rivet Buster

## Jumbo 11X Rivet Buster

**Please Specify Tool Usage - Concrete or Metal**



Point	10"	25	1.75	<b>51110</b>
	12"	25	2.50	<b>51112</b>
	18"	15	3.75	<b>51118</b>



Point	10"	25	2.00	<b>52110</b>
	12"	25	2.50	<b>52112</b>
	18"	15	4.00	<b>52118</b>

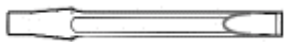

Chisel	10"	25	1.75	<b>51210</b>
	12"	25	2.50	<b>51212</b>
	18"	15	3.75	<b>51218</b>



Chisel	10"	25	2.00	<b>52210</b>
	12"	25	2.50	<b>52212</b>
	18"	15	4.00	<b>52218</b>



Side Cut Chisel	10"	25	1.75	<b>51310</b>
	12"	25	2.50	<b>51312</b>
	18"	15	3.75	<b>51318</b>



Side Cut Chisel	10"	25	2.00	<b>52310</b>
	12"	25	2.50	<b>52312</b>
	18"	15	4.00	<b>52318</b>



Chisel (Forged Corner To Corner)	10"	25	1.75	<b>51510</b>
	12"	25	2.50	<b>51512</b>
	18"	15	3.75	<b>51518</b>



Chisel (Forged Corner To Corner)	10"	25	2.00	<b>52510</b>
	12"	25	2.50	<b>52512</b>
	18"	15	4.00	<b>52518</b>

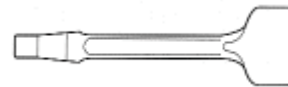

3" Wide Chisel	12"	20	2.75	<b>52612</b>
	18"	15	4.25	<b>52618</b>



Ripper	10"	25	1.75	<b>51810</b>
--------	-----	----	------	--------------



Ripper	10"	25	2.25	<b>52810</b>
--------	-----	----	------	--------------

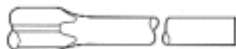

Clearance	Punch Diameter	Weight	Part Number
Back Out	5/8"	2.00	<b>5171004</b>
Punch	3/4"	2.00	<b>5171204</b>
	7/8"	2.00	<b>5171404</b>
4" Clearance			

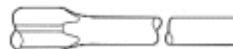

Clearance	Punch Diameter	Weight	Part Number
Back Out	5/8"	2.50	<b>5271004</b>
Punch	3/4"	2.50	<b>5271204</b>
	7/8"	2.50	<b>5271404</b>
4" Clearance	1"	2.50	<b>5271604</b>

Telephone: (724) 337-4700

Toll Free: (800) 359-6408

Fax Number: (724) 337-4707

5

Email: [pioneer@breakersteel.com](mailto:pioneer@breakersteel.com)

Website: [www.breakersteel.com](http://www.breakersteel.com)



# Chipping Hammer Tools

**Item      Length      Box Qty      Weight      Part Number**

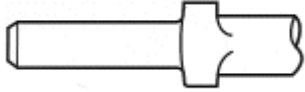

**Retainer Type**

**.680" Round Shank - Oval Collar**

Point	9"	25	1.25	<b>36109</b>
	12"	25	1.75	<b>36112</b>
	18"	20	2.50	<b>36118</b>
	24"	20	3.50	<b>36124</b>
	36"		5.25	<b>36136</b>
	48"		7.00	<b>36148</b>
	60"		8.75	<b>36160</b>
	72"		10.50	<b>36172</b>
Chisel	9"	25	1.25	<b>36209</b>
	12"	25	1.75	<b>36212</b>
	18"	20	2.50	<b>36218</b>
	24"	20	3.50	<b>36224</b>
	36"		5.25	<b>36236</b>
	48"		7.00	<b>36248</b>
	60"		8.75	<b>36260</b>
	72"		10.50	<b>36272</b>
1-1/2" Chisel	9"	25	1.25	<b>36309</b>
	12"	25	1.75	<b>36312</b>
	18"	20	2.50	<b>36318</b>
2" Chisel	9"	25	1.25	<b>36409</b>
	12"	25	1.75	<b>36412</b>
	18"	20	2.50	<b>36418</b>
3" Chisel	9"	25	1.25	<b>36509</b>
	12"	20	1.75	<b>36512</b>
	18"	20	2.50	<b>36518</b>



**Bushing Tool - 1-3/4" Head, 16 Teeth**

One Piece		15	3.00	<b>3670</b>
-----------	--	----	------	-------------

**Item      Length      Box Qty      Weight      Part Number**

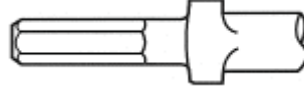

**Retainer Type**

**.580" Hex - Oval Collar**

Point	9"	25	1.25	<b>35109</b>
	12"	25	1.75	<b>35112</b>
	18"	20	2.50	<b>35118</b>
	24"	20	3.50	<b>35124</b>
	36"		5.25	<b>35136</b>
	48"		7.00	<b>35148</b>
	60"		8.75	<b>35160</b>
	72"		10.50	<b>35172</b>
Chisel	9"	25	1.25	<b>35209</b>
	12"	25	1.75	<b>35212</b>
	18"	20	2.50	<b>35218</b>
	24"	20	3.50	<b>35224</b>
	36"		5.25	<b>35236</b>
	48"		7.00	<b>35248</b>
	60"		8.75	<b>35260</b>
	72"		10.50	<b>35272</b>
1-1/2" Chisel	9"	25	1.25	<b>35309</b>
	12"	25	1.75	<b>35312</b>
	18"	20	2.50	<b>35318</b>
2" Chisel	9"	25	1.25	<b>35409</b>
	12"	25	1.75	<b>35412</b>
	18"	20	2.50	<b>35418</b>
3" Chisel	9"	25	1.25	<b>35509</b>
	12"	20	1.75	<b>35512</b>
	18"	20	2.50	<b>35518</b>



**Bushing Tool - 1-3/4" Head, 16 Teeth**

One Piece		15	3.00	<b>3570</b>
-----------	--	----	------	-------------

**Telephone:** (724) 337-4700

**Toll Free:** (800) 359-6408

**Fax Number:** (724) 337-4707

**6**

**Email:** [pioneer@breakersteel.com](mailto:pioneer@breakersteel.com)

**Website:** [www.breakersteel.com](http://www.breakersteel.com)

# Chipping Hammer Tools



**Item      Length      Box Qty      Weight      Part Number**

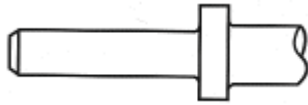

**Retainer Type**

**.680" Round Shank - Round Collar**

Point	9"	25	1.25	<b>36109R</b>
	12"	25	1.75	<b>36112R</b>
	18"	20	2.50	<b>36118R</b>
	24"	20	3.50	<b>36124R</b>
	36"		5.25	<b>36136R</b>
	48"		7.00	<b>36148R</b>
	60"		8.75	<b>36160R</b>
	72"		10.50	<b>36172R</b>
Chisel	9"	25	1.25	<b>36209R</b>
	12"	25	1.75	<b>36212R</b>
	18"	20	2.50	<b>36218R</b>
	24"	20	3.50	<b>36224R</b>
	36"		5.25	<b>36236R</b>
	48"		7.00	<b>36248R</b>
	60"		8.75	<b>36260R</b>
	72"		10.50	<b>36272R</b>
1-1/2" Chisel	9"	25	1.25	<b>36309R</b>
	12"	25	1.75	<b>36312R</b>
	18"	20	2.50	<b>36318R</b>
2" Chisel	9"	25	1.25	<b>36409R</b>
	12"	25	1.75	<b>36412R</b>
	18"	20	2.50	<b>36418R</b>
3" Chisel	9"	25	1.25	<b>36509R</b>
	12"	20	1.75	<b>36512R</b>
	18"	20	2.50	<b>36518R</b>



**Bushing Tool - 1-3/4" Head, 16 Teeth**

One Piece		15	3.00	<b>3670R</b>
-----------	--	----	------	--------------

**Item      Length      Box Qty      Weight      Part Number**

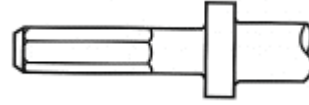

**Retainer Type**

**.580" Hex Shank - Round Collar**

Point	9"	25	1.25	<b>35109R</b>
	12"	25	1.75	<b>35112R</b>
	18"	20	2.50	<b>35118R</b>
	24"	20	3.50	<b>35124R</b>
	36"		5.25	<b>35136R</b>
	48"		7.00	<b>35148R</b>
	60"		8.75	<b>35160R</b>
	72"		10.50	<b>35172R</b>
Chisel	9"	25	1.25	<b>35209R</b>
	12"	25	1.75	<b>35212R</b>
	18"	20	2.50	<b>35218R</b>
	24"	20	3.50	<b>35224R</b>
	36"		5.25	<b>35236R</b>
	48"		7.00	<b>35248R</b>
	60"		8.75	<b>35260R</b>
	72"		10.50	<b>35272R</b>
1-1/2" Chisel	9"	25	1.25	<b>35309R</b>
	12"	25	1.75	<b>35312R</b>
	18"	20	2.50	<b>35318R</b>
2" Chisel	9"	25	1.25	<b>35409R</b>
	12"	25	1.75	<b>35412R</b>
	18"	20	2.50	<b>35418R</b>
3" Chisel	9"	25	1.25	<b>35509R</b>
	12"	20	1.75	<b>35512R</b>
	18"	20	2.50	<b>35518R</b>



**Bushing Tool - 1-3/4" Head, 16 Teeth**

One Piece		15	3.00	<b>3570R</b>
-----------	--	----	------	--------------

Telephone: (724) 337-4700

Toll Free: (800) 359-6408

Fax Number: (724) 337-4707



7

Email: [pioneer@breakersteel.com](mailto:pioneer@breakersteel.com)

Website: [www.breakersteel.com](http://www.breakersteel.com)



# Chipping Hammer Tools

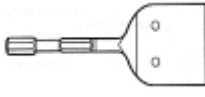

Item	Length	Box Qty	Weight	Part Number	Item	Length	Box Qty	Weight	Part Number
 <p><b>Retainer Type</b></p> <p><b>.401 Round Shank Parker Taper</b></p>					 <p><b>Retainer Type</b></p> <p><b>.498 Round Shank Parker Taper</b></p>				
Point	7"	25	.50	<b>390107</b>	Point	7"	25	.50	<b>393107</b>
	12"	25	1.00	<b>390112</b>		12"	25	1.00	<b>393112</b>
	18"	25	1.25	<b>390118</b>		18"	25	1.25	<b>393118</b>
1/2" Chisel	7"	25	.50	<b>390207</b>	1/2" Chisel	7"	25	.50	<b>393207</b>
	12"	25	1.00	<b>390212</b>		12"	25	1.00	<b>393212</b>
	18"	25	1.25	<b>390218</b>		18"	25	1.25	<b>393218</b>
3/4" Chisel	7"	25	.50	<b>392207</b>	3/4" Chisel	7"	25	.50	<b>394207</b>
	12"	25	1.00	<b>392212</b>		12"	25	1.00	<b>394212</b>
	18"	25	1.25	<b>392218</b>		18"	25	1.25	<b>394218</b>
1-1/4" Chisel	7"	25	.50	<b>390307</b>	1-1/4" Chisel	7"	25	.50	<b>393307</b>
	12"	25	1.00	<b>390312</b>		12"	25	1.00	<b>393312</b>
	18"	25	1.25	<b>390318</b>		18"	25	1.25	<b>393318</b>
	7"	25	.50	<b>390707</b>		7"	25	.50	<b>393707</b>
1-1/4" Angle Chisel	12"	25	1.00	<b>390712</b>	1-1/4" Angle Chisel	12"	25	1.00	<b>393712</b>
	18"	25	1.25	<b>390718</b>		18"	25	1.25	<b>393718</b>

**Floor Chisel for Long Reach Scaler**

Item	Part Number
 5/8" Hex Shank x 4" Floor Chisel	<b>471404</b>
 4" Milled Adapter	<b>472404</b>

Note: Each Milled Adapter comes with 2 each: Bolts, Nuts and Lock Washers

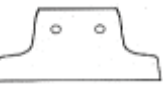
**Blade for Long Reach Scaler**

Item	Part Number
 4" Wide Scraper Blade (Each)	<b>473404</b>
4" Wide Scraper Blade (Pkg of 4)	<b>474404</b>
 8" Wide Scraper Blade (Each)	<b>473408</b>
8" Wide Scraper Blade (Pkg of 4)	<b>474408</b>
 12" Wide Scraper Blade (Each)	<b>473412</b>
12" Wide Scraper Blade (Pkg of 4)	<b>474412</b>
Six Pack (2 of each blade size)	<b>474466</b>

Telephone: (724) 337-4700  
 Toll Free: (800) 359-6408  
 Fax Number: (724) 337-4707





Email: [pioneer@breakersteel.com](mailto:pioneer@breakersteel.com)  
 Website: [www.breakersteel.com](http://www.breakersteel.com)



# Weld Flux Scaling Chisels

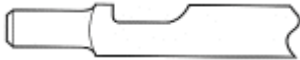

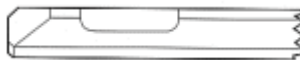
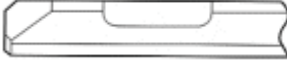
Item	Length	Weight	Part Number	Item	Length	Weight	Part Number
							
<b>For Cleco B-1, Rotor S-1, CP 9356, IR 183</b>				<b>For Master Power 205, 206, Black &amp; Decker</b>			
3/4" Chisel	7"	.50	41207	3/4" Chisel	7"	.50	43207
	12"	1.00	41212		12"	1.00	43212
	18"	1.50	41218		18"	1.50	43218
1-3/8" Wide Chisel	7"	.50	41307	1-3/8" Wide Chisel	7"	.50	43307
	12"	1.00	41312		12"	1.00	43312
	18"	1.50	41318		18"	1.50	43318
2" Wide Scaler	7"	.50	41407	2" Wide Scaler	7"	.50	43407
	12"	1.00	41412		12"	1.00	43412
	18"	1.50	41418		18"	1.50	43418
3" Wide Scaler	7"	.50	41507	3" Wide Scaler	7"	.50	43507
	12"	1.00	41512		12"	1.00	43512
	18"	1.50	41518		18"	1.50	43518
1-3/8" Angle Scaler	7"	.50	41707	1-3/8" Angle Scaler	7"	.50	43707
	12"	1.00	41712		12"	1.00	43712
	18"	1.50	41718		18"	1.50	43718
							
<b>For Ingersoll-Rand 171, 181</b>				<b>For Chicago Pneumatic, Thor, Dallet</b>			
3/4" Chisel	7"	.50	42207	3/4" Chisel	7"	.50	44207
	12"	1.00	42212		12"	1.00	44212
	18"	1.50	42218		18"	1.50	44218
1-3/8" Wide Chisel	7"	.50	42307	1-3/8" Wide Chisel	7"	.50	44307
	12"	1.00	42312		12"	1.00	44312
	18"	1.50	42318		18"	1.50	44318
2" Wide Scaler	7"	.50	42407	2" Wide Scaler	7"	.50	44407
	12"	1.00	42412		12"	1.00	44412
	18"	1.50	42418		18"	1.50	44418
3" Wide Scaler	7"	.50	42507	3" Wide Scaler	7"	.50	44507
	12"	1.00	42512		12"	1.00	44512
	18"	1.50	42518		18"	1.50	44518
1-3/8" Angle Scaler	7"	.50	42707	1-3/8" Angle Scaler	7"	.50	44707
	12"	1.00	42712		12"	1.00	44712
	18"	1.50	42718		18"	1.50	44718

Telephone: (724) 337-4700

Toll Free: (800) 359-6408

Fax Number: (724) 337-4707



9



Email: [pioneer@breakersteel.com](mailto:pioneer@breakersteel.com)



Website: [www.breakersteel.com](http://www.breakersteel.com)



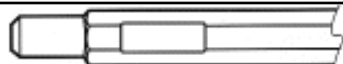

# Electric Hammer Tools

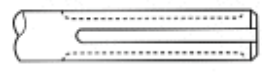
Item	Length	Box Qty	Weight	Part Number
	<b>3/4" Bosch</b> 11302, 11305			
Point	12"	40	1.50	<b>7010</b>
	18"	25	2.25	<b>7030</b>
Chisel	12"	40	1.50	<b>7020</b>
	18"	25	2.25	<b>7040</b>
1-1/2" Chisel	12"	40	1.50	<b>7050</b>
2" Chisel	12"	25	1.75	<b>7055</b>
	18"	25	2.50	<b>7056</b>
2" Scraping Chisel	14"	25	2.00	<b>7057</b>
3" Chisel	12"	25	1.75	<b>7060</b>
	<b>1-Piece Bushing Tool</b>			
1-3/4" x 1-3/4"	15	2.75		<b>7070</b>
	<b>Ground Rod Driver</b>			
5/8"	15	2.50		<b>7080</b>
3/4"	15	2.50		<b>7090</b>

Item	Length	Box Qty	Weight	Part Number
	<b>3/4" Bosch</b> 11202, 11203, 11204, 11205, 11209, 11214, 11306			
Point	12"	40	1.50	<b>7110</b>
	18"	25	2.25	<b>7130</b>
Chisel	12"	40	1.50	<b>7120</b>
	18"	25	2.25	<b>7140</b>
1-1/2" Chisel	12"	40	1.50	<b>7150</b>
2" Chisel	12"	25	1.75	<b>7155</b>
	18"	25	2.50	<b>7156</b>
2" Scraping Chisel	14"	25	2.00	<b>7157</b>
3" Chisel	12"	25	1.75	<b>7160</b>
	<b>1-Piece Bushing Tool</b>			
1-3/4" x 1-3/4"	15	2.75		<b>7170</b>
	<b>Ground Rod Driver</b>			
5/8"	15	2.50		<b>7180</b>
3/4"	15	2.50		<b>7190</b>

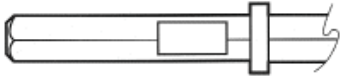
Item	Length	Box Qty	Weight	Part Number
	<b>SDS Max For Bosch</b> 11312E, 11311EVS, 11313EVS			
Point	12"	40	1.00	<b>7310</b>
	18"	30	1.75	<b>7330</b>
Chisel	12"	40	1.00	<b>7320</b>
	18"	30	1.75	<b>7340</b>
2" Chisel	12"	30	1.25	<b>7342</b>
3" Chisel	12"	30	1.25	<b>7360</b>
Asphalt Cutter				<b>7350</b>
Clay Spade				<b>7355</b>
	<b>1-Piece Bushing Tool</b>			
1-3/4" x 1-3/4"	15	2.75		<b>7370</b>

Item	Length	Box Qty	Weight	Part Number
	<b>1-1/8" x 6" Bosch Brute</b> 11304, B&D 5027, Hitachi H65, H90SB, Kango 2500			
Point	14"	8	6.00	<b>7410</b>
	18"	8	7.50	<b>7430</b>
Chisel	14"	8	6.00	<b>7420</b>
	18"	8	7.50	<b>7440</b>
Asphalt Cutter	11"	6	9.00	<b>7450</b>
Clay Spade	15"	6	9.50	<b>7455</b>
3" Chisel	14"	6	7.00	<b>7460</b>
	<b>1-Piece Bushing Tool</b>			
2" x 2"	9"	8	7.50	<b>7470</b>

Telephone: (724) 337-4700  
 Toll Free: (800) 359-6408  
 Fax Number: (724) 337-4707

Email: [pioneer@breakersteel.com](mailto:pioneer@breakersteel.com)  
 Website: [www.breakersteel.com](http://www.breakersteel.com)

# Drill Steel



**Shank Size   Length  
under  
collar   Weight   Part Number**



**H Thread Drill Steel**

7/8 x 3-1/4	1'	3	87312
	1.5'	4	87318
	2'	5	87324
	2.5'	6	87330
	3'	7	87336
	4'	9	87348
	5'	11	87360
	6'	14	87372
	8'	18	87396
	10'	22	873120
7/8 x 4-1/4	1'	3	87412
	1.5'	4	87418
	2'	5	87424
	2.5'	6	87430
	3'	7	87436
	4'	9	87448
	5'	11	87460
	6'	14	87472
	8'	18	87496
	10'	22	874120
1 x 4-1/4	1'	4	81012
	1.5'	5	81018
	2'	7	81024
	2.5'	9	81030
	3'	10	81036
	4'	12	81048
	5'	15	81060
	6'	18	81072
	8'	23	81096
	10'	28	810120

**Longer Lengths Available**

**Shank Size   Length  
under  
collar   Weight   Part Number**



**H Thread Extensions**

7/8	1'	2.25	87X12
7/8	2'	4.25	87X24
7/8	3'	6.50	87X36
7/8	4'	8.50	87X48
1	1'	3.50	81X12
1	2'	6.25	81X24
1	3'	9.25	81X36
1	4'	11.50	81X48



**Bit Size**

**Carbide Rock Bits**

**Part Number**

1-3/8"	8011CM
1-1/2"	8012CM
1-5/8"	8013CM
1-3/4"	8014CM
1-7/8"	8015CM
2"	8016CM
2-1/4"	8017CM
2-1/2"	8018CM
2-3/4"	8020CM
3"	8021CM

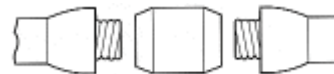

**Accessories**

H to D Thread Drill Steel Adaptor	8119
H Thread Coupling	8119C

Telephone: (724) 337-4700

Toll Free: (800) 359-6408

Fax Number: (724) 337-4707

11

Email: [pioneer@breakersteel.com](mailto:pioneer@breakersteel.com)

Website: [www.breakersteel.com](http://www.breakersteel.com)



# Integral Drill Steel

**Shank Length Drilling Bit Part Number**  
**under Depth Size**  
**collar**



**C9 Integral**

For Chicago-Pneumatic  
 CP-9A  
 Sullair MRD-9  
 Thor 5LHD  
 APT 109

<u>3/4 Rd x 3-3/4 Slotted Shank</u>	Shank Length	Drilling Depth	Bit Size	Part Number
	13"	8"	1/2"	8913090500
			5/8"	8913090625
			3/4"	8913090750
			7/8"	8913090875
			1"	8913091000
	17"	12"	3/4"	8917120750
			7/8"	8917120875
			1"	8917121000
			1-1/8"	8917121125

**Shank Length Drilling Bit Part Number**  
**under Depth Size**  
**collar**



**Integral**

**3-1/4" Hx Shank Models**

APT 115-137-155  
 CP 00114RR, 0022, 32A-87  
 IR JH30A1, JH40C1  
 Harper 4108, 4112  
 Jet RD-15, RD-30, RD-60  
 Sullair MRD-30, 40, 50  
 Thor 14D, 15D

Shank Length	Drilling Depth	Bit Size	Part Number
7/8 Hx x 3-1/4	18"	15"	7/8" 8318150875
			1" 8318151000
			1-1/8" 8318151125
	24"	21"	7/8" 8324210875
			1" 8324211000
			1-1/8" 8324211125
		1-3/8"	8324211375

**4-1/4" Hx Shank Models**

APT 137-155  
 CP 0032A, 87A  
 IR JH30A2, JH40C2  
 Harper 4108, 4112  
 Sullair MRD-30, 40, 50, 55

Shank Length	Drilling Depth	Bit Size	Part Number
7/8 Hx x 4-1/4	18"	15"	7/8" 8418150875
			1" 8418151000
			1-1/8" 8418151125
	24"	21"	7/8" 8424210875
			1" 8424211000
			1-1/8" 8424211125
		1-3/8"	8424211375

**Telephone:** (724) 337-4700  
**Toll Free:** (800) 359-6408  
**Fax Number:** (724) 337-4707

**Email:** [pioneer@breakersteel.com](mailto:pioneer@breakersteel.com)  
**Website:** [www.breakersteel.com](http://www.breakersteel.com)

# Boom Mounted



Model	Diam	Length	Weight	Chisel	Point
					
<b><u>Demolition Tools</u></b>			<b>Other Models and Lengths Available</b>		
<b><u>ALLIED</u></b>					
AR 70	2.8	28	40	9A07028CP	9A07028PP
Hy Ram 380	3.2	36	70	9A38036CP	9A38036PP
Hy Ram 710 / 711	2.5	24	24	9A71024CP	9A71024PP
Hy Ram 730	3.2	36	71	9A73036CP	9A73036PP
Hy Ram 735	3.5	39	94	9A73539CP	9A73539PP
Hy Ram 745	4.0	40	120	9A74540CP	9A74540PP
<b><u>ATLAS COPCO</u></b>					
180	2.5	30	37	9AT18030CP	9AT18030PP
410	2.6	24	29	9AT41024CP	9AT41024PP
	2.6	36	48	9AT41036CP	9AT41036PP
610	3.2	33	62	9AT61033CP	9AT61033PP
<b><u>BOBCAT</u></b>					
680	2.1	20	20	9M68020CP	9M68020PP
700	2.0	21	16	9M70021CP	9M70021PP
850 / 950	2.5	24	28	9M85024CP	9M85024PP
	2.5	28	33	9M85028CP	9M85028PP
880	2.5	23	25	9M88023CP	9M88023PP
980	2.8	26	43	9M98026CP	9M98026PP
2500 / 2600 / 3500	2.5	22	26	9M25022CP	9M25022PP
	2.5	28	32	9M25028CP	9M25028PP
5500	2.8	28	40	9M55028CP	9M55028PP
<b><u>HUSKIE</u></b>					
HH 100	1.6	17	9	9UH10017CP	9UH10017PP
HH 300 / HB 30	2.4	24	30	9UH30024CP	9UH30024PP
HH 500	2.6	24	32	9UH50024CP	9UH50024PP
HH 500-2	2.6	24	32	9UH500224CP	9UH500224PP
HH 750	3.0	29	48	9UH75029CP	9UH75029PP
HH 750-2	3.0	29	48	9UH750229CP	9UH750229PP
HH 1000	3.5	32	82	9UH01M32CP	9UH01M32PP
HH 2000	4.5	36	140	9UH02M36CP	9UH02M36PP
<b><u>INDECO</u></b>					
HP 1000	2.9	26	40	9IHP100026CP	9IHP100026PP
	2.9	30	47	9IHP100030CP	9IHP100030PP
HP 2000	4.5	38	140	9IHP200038CP	9IHP200038PP
HP 3000	4.7	40	165	9IHP300040CP	9IHP300040PP
HP 500	2.2	23	22	9IHP50023CP	9IHP50023PP
HP 750	2.7	24	30	9IHP75024CP	9IHP75024PP
MES 350 / 351	2.2	23	22	9I35023CP	9I35023PP
MES 523 / 553	2.9	26	40	9I52326CP	9I52326PP
	2.9	30	47	9I52330CP	9I52330PP
MES 621 / 650	3.1	26	50	9I62126CP	9I62126PP
	3.1	30	57	9I62130CP	9I62130PP
MES 1750	4.5	38	140	9I175038CP	9I175038PP
MES 2000	4.7	40	165	9I200040CP	9I200040PP

Telephone: (724) 337-4700

Toll Free: (800) 359-6408

Fax Number: (724) 337-4707

13

Email: [pioneer@breakersteel.com](mailto:pioneer@breakersteel.com)

Website: [www.breakersteel.com](http://www.breakersteel.com)



# Boom Mounted

Model	Diam	Length	Weight	Chisel	Point
			<b>Demolition Tools</b>		<b>Other Models and Lengths Available</b>
<b><u>KENT</u></b>					
KF 4	2.4	22	24	9KKF422CP	9KKF422PP
KF 6	3.0	26	48	9KKF626CP	9KKF626PP
KF 9	3.5	30	72	9KKF930CP	9KKF930PP
KF 12	4.2	37	115	9KKF1237CP	9KKF1237PP
KF 19	4.7	45	190	9KKF1945CP	9KKF1945PP
KF 22	5.3	48	270	9KKF2248CP	9KKF2248PP
KF 35	6.0	51	360	9KKF3551CP	9KKF3551PP
KHB 3 G	2.4	23	23	9K03G23CP	9K03G23PP
<b><u>NPK</u></b>					
E 210	4.9	45	205	9NE21045CP	9NE21045PP
H 10 XB	5.0	44	195	9NH10X44CP	9NH10X44PP
H 16 X	5.7	51	345	9NH16X51CP	9NH16X51PP
<b><u>OKADA</u></b>					
OKB 302	2.4	22	25	9O030222CP	9O030222PP
OKB 303	2.7	22	38	9O030322CP	9O030322PP
OKB 304	2.9	28	48	9O030428CP	9O030428PP
OKB 304 B	2.9	27	47	9O0304B27CP	9O0304B27PP
TOP 60	3.3	36	85	9OTOP6036CP	9OTOP6036PP
TOP 100	4.9	48	240	9OTOP20048CP	9OTOP20048PP
<b><u>RAMMER</u></b>					
S 21	1.8	19	12	9RS2119CP	9RS2119PP
S 22	2.0	21	22	9RS2221CP	9RS2221PP
S 25	2.7	29	49	9RS2529CP	9RS2529PP
	2.7	39	89	9RS2539CP	9RS2539PP
E 64	4.2	41	145	9RE6441CP	9RE6441PP
E 68	5.1	43	215	9RE6843CP	9RE6843PP
<b><u>STANLEY</u></b>					
MB 250 / 350	2.5	22	25	9S25022CP	9S25022PP
MB 550	2.8	28	40	9S55028CP	9S55028PP
50 EXS	5.5	51	316	9S50EXS51CP	9S50EXS51PP
<b><u>TELEDYNE</u></b>					
TB 325	2.9	30	48	9Y32530CP	9Y32530PP
TB 725	4.5	36	140	9Y72536CP	9Y72536PP
TB 830 X	4.5	36	140	9Y83036CP	9Y83036PP
<b><u>TRAMAC</u></b>					
BRP 85 / 95 / 100	2.5	24	29	9T10024CP	9T10024PP
BRH 125	3.1	26	53	9T12530CP	9T12530PP
BRH 400	3.8	34	99	9T40034CP	9T40034PP
BRH 625 / 900	4.6	40	185	9T62540CP	9T62540PP
<b><u>UB</u></b>					
UB 103	2.8	30	50	9U10330CP	9U10330PP
UB 300	2.7	28	28	9U30028CP	9U30028PP

Telephone: (724) 337-4700

Toll Free: (800) 359-6408

Fax Number: (724) 337-4707

Email: [pioneer@breakersteel.com](mailto:pioneer@breakersteel.com)

Website: [www.breakersteel.com](http://www.breakersteel.com)



Pioneer "Long Life" boom mounted demolition points and chisels are made of Ultra Grade Alloy. Pioneer provides tools for all hammers. Please call for unlisted models, pricing and availability.

## Safety Hints and Guidelines

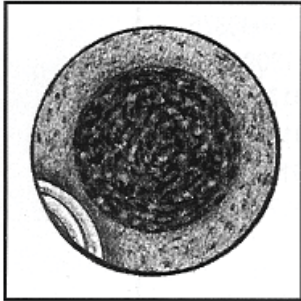

### **Fatigue Failure**

A thumbnail crack develops from prying or the use of dull loads.

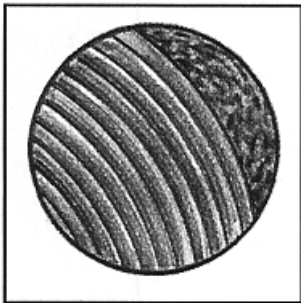

### **Re-sharpening Failure**

Usually occurs 3" to 5" from the workend due to improper heating during re-sharpening. The coarse lines show the absence of hardness after re-sharpening.

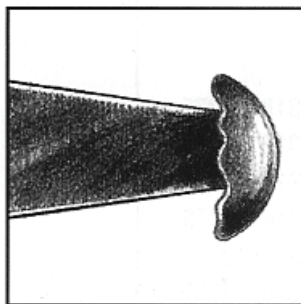

### **Mushrooming**

Intense heat is generated when penetration is not achieved by the workend. The folding over is the result of that heat softened condition.

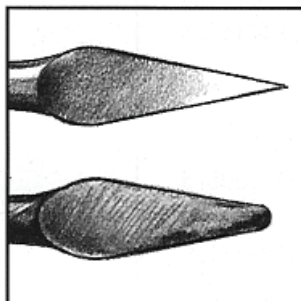

### **Wear**

Tools showing considerable wear lose their cutting efficiency, transferring strain onto the shank, body and blade, resulting in breakage.

It is important to remember that relatively few tools break as a result of material or workmanship defects. A defective tool is likely to fail immediately due to severe stresses imparted by the heavy, repetitive blows of the hammer. A tool which breaks after considerable service, evidenced by a well worn shank and blade, is not likely to be defective but would fall into one of the categories noted at left. To prolong tool life and insure safe use of the product, here are a few guidelines to follow.

- Do not use tools for unintended purposes, i.e. using an Asphalt Cutter to break concrete.
- Do not allow tools to overheat in service as it will draw the temper of the tool and cause the points or blade to soften and mushroom.
- Do not run tools idle in the hammers. Tools are designed to dispense the shock of the hammer into the work; free running causes excessive build-up of stress in the tool itself and creates fatigue points.
- Keep workends sharp and cutting efficiently. Have tools sharpened or redressed on a regular basis by a qualified blacksmith.
- Keep hammers properly maintained, regularly replacing worn bushings or pistons and lubricating parts.
- Educate the user in the proper air or hydraulic pressure required during each phase of operation; avoid using full pressure to start operation which causes tools to plow into work rather than cutting work.
- Do not pry with any hand or power hammer accessory tool.
- Encourage use of in-line oilers and filters for proper lubricating during operation.

Telephone: (724) 337-4700

Toll Free: (800) 359-6408

Fax Number: (724) 337-4707

Email: [pioneer@breakersteel.com](mailto:pioneer@breakersteel.com)

Website: [www.breakersteel.com](http://www.breakersteel.com)

# PIONEER

Tool & Forge, Inc.

Pioneer quality  
makes the difference  
when it comes to  
air, electric and hydraulic  
hammer accessories

Email:

[pioneer@breakersteel.com](mailto:pioneer@breakersteel.com)

Web:

[www.breakersteel.com](http://www.breakersteel.com)

For more information  
please contact us:

Pioneer Tool & Forge, Inc.  
101 Sixth Street  
New Kensington, PA 15068

Tel: (800) 359-6408

Tel: (724) 337-4700

Fax: (724) 337-4707

ISO 9001 : 2000 Compliant